

INSTRUCTION MANUAL

# MSW1150

HI-FI VERTICAL CD/MP3 SHELF SYSTEM WITH  
USB FLASH/SD CARD READERS, AM/FM TUNER,  
AND 6-WAY DETACHABLE SPEAKERS

## Table Of Contents

Caution / Warning.....	02
Location of Controls.....	03
Remote Control Functions .....	04
Connection of Speaker Boxes .....	04
Power Supply.....	04
Quick Start .....	05
General Operation	
Important Operating Instructions .....	07
Battery Backup.....	07
System Setup and Precautions.....	07
Digital Clock Functions .....	08
Timer Function .....	09
Sleep Function .....	09
Electronic Volume Control .....	10
Volume Memory Level.....	10
Music Equalizer.....	10
Auto-Start Playback Function .....	10
Radio Operation	
Scan Mode .....	11
Seek Mode .....	11
Station Preset Functions .....	11
CD Player Operation	
Insert and Removal of Disc .....	12
Normal CD Operation .....	12
Text Display Mode (ID3).....	13
Searching for Song by Name .....	14
(MP3 Discs Only)	
Searching for Song by Album.....	15
(MP3 Discs Only)	
USB Flash Drive / SD Card Operation	
MP3 Playback .....	17
Displaying the Song/Title Name (ID3 Tag).....	17
Play Modes .....	18
Anti-Skip [ESP].....	18
Line-in Connection.....	18
Connecting an External Subwoofer .....	19
Specifications .....	19
System Setup Procedure .....	20
Mounting Guides .....	21

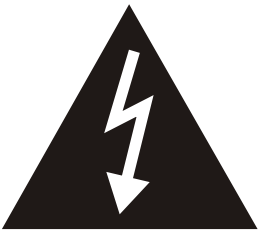

The lightning flash and arrow head within the triangle is a warning sign alerting you of "dangerous voltage" inside the product.

## CAUTION

**RISK OF ELECTRIC SHOCK  
DO NOT OPEN**

**WARNING:** To reduce the risk of electric shock, do not remove cover (or back). No user-serviceable parts inside. Refer servicing to qualified service personnel.



The exclamation point within the triangle is a warning sign alerting you of important instructions accompanying the product.

### **WARNING:**

TO REDUCE THE RISK OF FIRE OR ELECTRIC SHOCK, DO NOT EXPOSE THIS APPLIANCE TO DRIPPING OR SPLASHING LIQUIDS.



**CAUTION  
DO NOT EXPOSE TO DRIPPING OR SPLASHING LIQUIDS!**

**CAUTION: GROUNDING OR POLARIZATION. THE PRECAUTIONS SHOULD BE TAKEN SO THAT THE WIDER BLADE OF THE AC PLUG MUST MATCH THE SLOT IN RECEPTACLE "WALL SOCKET".**

CAUTION: INVISIBLE LASER RADIATION WHEN OPEN AND INTERLOCKS DEFEATED. AVOID EXPOSURE TO BEAM.

VORSICHT: UNSICHTBARE LASERSTRAHLUNG TRITTAUS, WENN DECKEL GEÖFFNET UND WENN SICHERHEITSVERRIEGELUNG ÜBERBRÜCKT IST. NICHT DEM STRAHL AUSSETZEN!

VARNING: OSYNLIG LASERSTRÅLNING NÄR DENNA DEL ÄR ÖPPNAD OCH SPÄRR ÄR URKOPPLAND. STRÅLEN ÄR FARLIG.

ADVARSEL: USYNLIG LASERSTRÅLING VED ÅBNING. NÅR SIKKERHEDSAFBRYDERE ER UDE AF FUNKTION. UNDGÅ UDS/ETTELSE FOR STRÅLING.

ATTENZIONE: RADIONI LASER INVISIBILE. NON GUARDARE DIRETTAMENTE NELLA SORGENTE DELLASER.

ACHTUNG: LASERLINSE NICHT BERÜHREN UNSICHTBARER LASERSTRAHL.

AVISO: ALENTE NUNCA DEVE SER TOCADA.



CLASS 1 LASER PRODUCT  
KLASSE 1 LASER PRODUKT  
LASER DE CLASSE  
LASER DI PRIMA CLASSE  
KLASSE 1 LASER  
LASER PRIMERA CLASE  
LASER CLASSE 1  
KLASSE 1 LASER PRODUKT

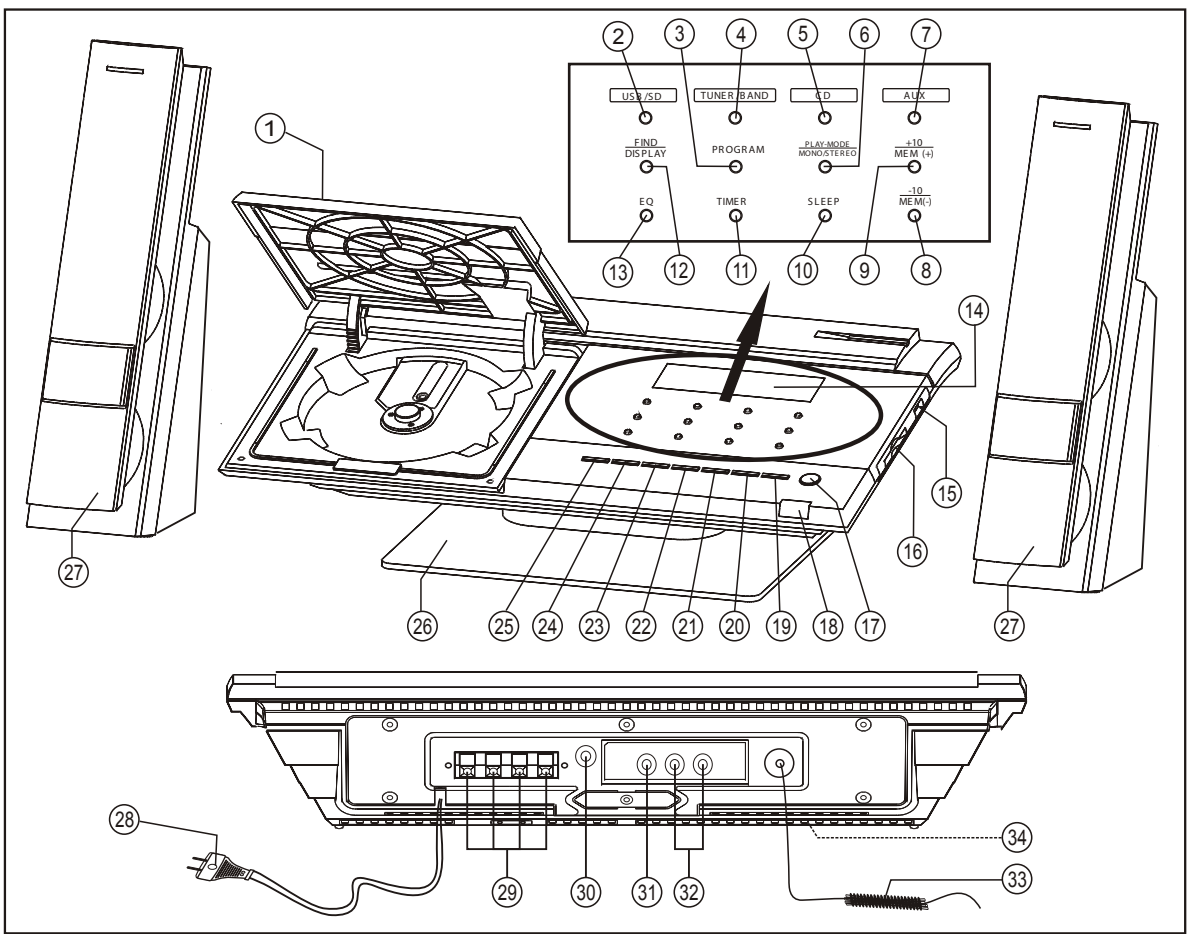

- |   |   |
|---|---|
| 01. CD door   | 19. Volume up key                           |
| 02. USB / SD key  | 20. Volume down key                         |
| 03. CD programming key                                  | 21. CD next / Tune up key                   |
| 04. Tuner / Band key                                    | 22. CD stop key                             |
| 05. CD key  | 23. CD back / Tune down key                 |
| 06. Play mode / Mono stereo key                         | 24. CD play / Pause key                     |
| 07. Aux. key  | 25. CD door open / Close key                |
| 08. Mem (-) / CD -10 key                                | 26. Desk pedestal stand (removeable)        |
| 09. Mem (+) / CD +10 key                                | 27. Speakers                                |
| 10. Sleep key   | 28. AC cord plug                            |
| 11. Timer key   | 29. Speaker-out sockets (left and right)    |
| 12. Find / Display key                                  | 30. Headphone jack                          |
| 13. EQ (equalizer) key                                  | 31. Subwoofer output                        |
| 14. CD / Clock / Radio digital multi-functional display | 32. Audio line-in socket (left and right)   |
| 15. USB socket  | 33. FM antenna wire                         |
| 16. SD card socket                                      | 34. Backup battery compartment (under unit) |
| 17. On / Off key  |   |
| 18. Remote control sensor                               |   |

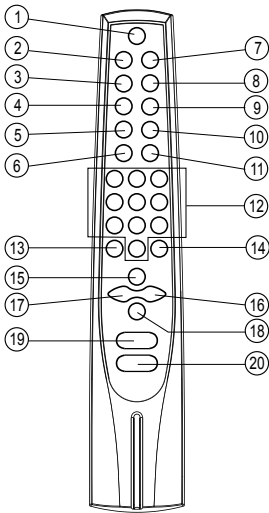

## Remote Control

- |                     |                               |
|---------------------|-------------------------------|
| 01. On / Off key    | 11. Memory up key             |
| 02. Find / M/S key  | 12. Direct keys (Number keys) |
| 03. Timer key       | 13. Mute key                  |
| 04. EQ key          | 14. Memory / Program key      |
| 05. Sleep key       | 15. CD play / Pause key       |
| 06. Memory down key | 16. CD Next / Tune-up key     |
| 07. Band key        | 17. CD back / Tune-down key   |
| 08. Intro key       | 18. CD stop / Band key        |
| 09. Function key    | 19. Volume up key             |
| 10. Repeat key      | 20. Volume down key           |

## Connection of Speakers

- Unwrap the speaker cords of both speakers.
- Insert the cables of the left speaker into the "Red" (+) and "Black" (-) speaker connectors which have the "L" indication on the backside of the unit.
- Insert the cables of the right speaker into the "Red" (+) and "Black" (-) speaker connectors which have the "R" indication on the backside of the unit.
- When inserting each wire into a connector, press firmly inwards on the connector's plastic knob (red or black part) and push only the exposed metal end of the wire all the way into the hole. Do not insert the plastic insulation of the wire into the holes.
- Important: Each speaker cable has 2 different wires with different colors or markings to indicate the 2 different polarities of each speaker. Please make sure to follow the same wire to connector combination for both left and right speakers. (Eg. If you insert the black wire of left speaker into the red left connector, then you should also follow same combination for right speaker.
- Place the speaker boxes as far apart as possible for best sound effect.

## Power Supply

- This unit works on normal household AC power.
- Make sure the set voltage of the unit matches your local voltage.
- Insert the plug of the AC cord into a wall outlet with AC power.
- Press the On/Off key to power on the unit.

### Important: How To Tell If Power Is "On"?

When the power is "On" the entire digital display will be lit up with a blue back light.

## Quick Start

1. Connect the speakers and table stand.
2. Plug the AC cord into a wall socket and connect the FM antenna wire.

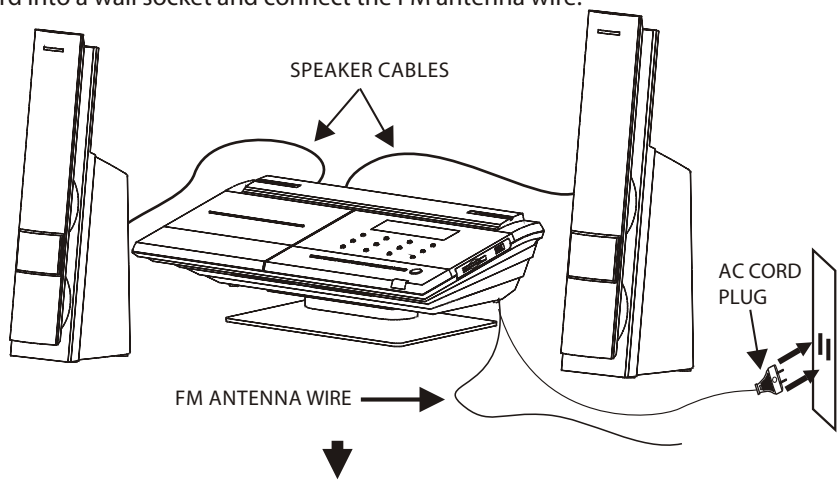

3. Press the **On/Off** key to switch "On" the unit.

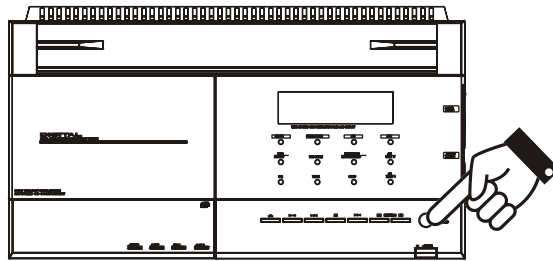

4. Listen to the CD player.
  - Press the **CD** key - "CD" will be displayed.
  - Press the Open/Close key.
  - Insert a disc (audio CD or MP3 CD).
  - The **CD** will automatically start playing.
  - Adjust volume **Vol +** or **Vol -** as needed.

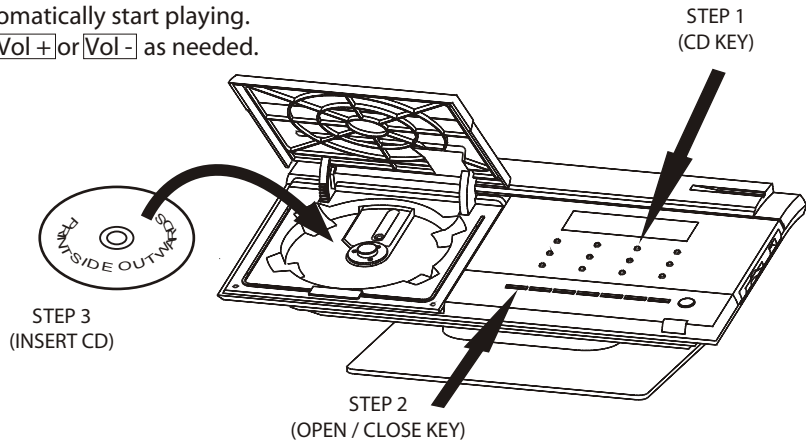

## 5. How to listen to the radio

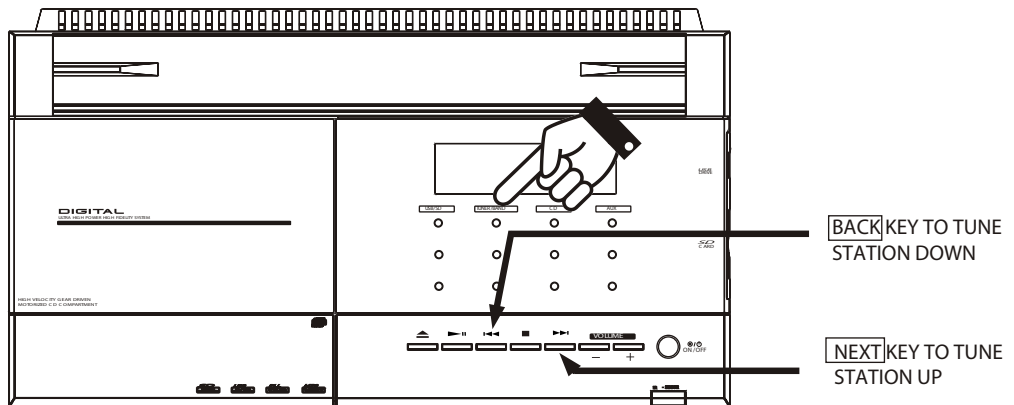

- Press **Tuner/Band** key to switch to Radio Mode.
- Press **Tuner** key to switch to "FM" radio band.
- Press **Tuner** key again to switch to "AM" radio band.
- Press and release **Next** key to tune radio frequency up.
- Press and release **Back** key to tune radio frequency down.
- Press and hold **Next** key (2 seconds) to scan up (seek to next station).
- Press and hold **Back** key (2 seconds) to scan down (seek to previous station).

## 6. Press the **On/Off** key to switch "On" the unit.

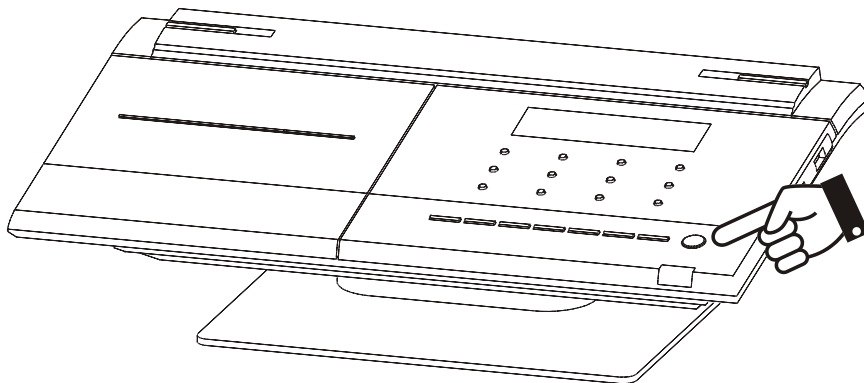

## Important Operating Instructions

- This unit is designed to operate without ever being totally powered "Off". It will either be "On" or in "Standby Mode".
- In "Standby Mode", the blue backlight of the digital display will be switched off. However, the clock display will still be viewable.
- When in "Standby Mode", you can use the power switch (on the remote control or on the front panel of the main unit) to turn "On" or "Off" the unit.

## Battery Backup

- This unit has a battery backup system which keeps certain vital information saved in its internal memory in case of power outage (i.e. blackout or AC cord accidentally becomes unplugged).
- To enable this battery backup feature, please insert 2 "AA" type batteries into the battery backup compartment which is located under the main unit.
- These batteries will last for several months, and must be replaced periodically to maintain the backup function.
- During a power outage, the battery backup system will save the time and programmed radio stations into its memory, so that when the AC power is resumed, the unit does not need to be re-programmed.
- Please note that the unit itself cannot be operated on battery backup power during power outage.
- The battery backup has a limited duration during a power outage. If the AC power remains off for long periods at a time, the battery backup system may not be able to keep the saved information in memory as the batteries themselves are limited in their life. For this reason, it is recommended to use good quality alkaline batteries, and to replace them periodically.
- When you are not using the unit for long periods, or if the unit will remain unplugged for many weeks, it is recommended to remove the batteries to prevent leakage and damage.

## System Setup and Precautions

- This unit is designed to be used on a desk (shelf or table) with or without the supplied pedestal, or as a wall mounted unit.
- Please refer to the separate section entitled: "System Setup Procedure" for the method of installing the pedestal or wall mounting bracket.
- Always position the unit away from direct sunlight or heaters and air-conditioning vents.
- Always position the unit with adequate ventilation at the rear and sides. Never block the ventilation holes of the unit.

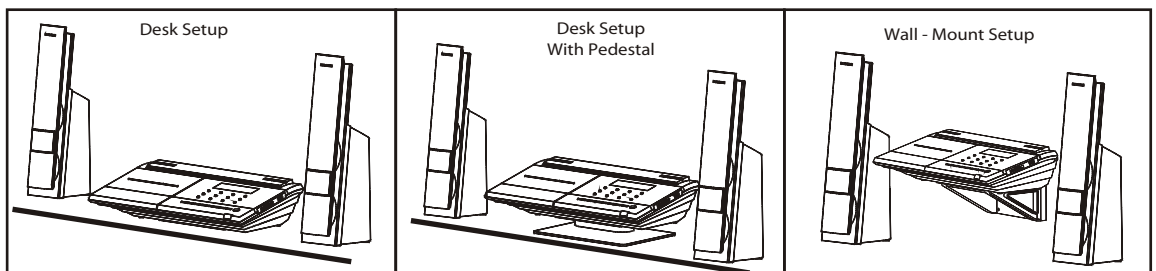



## Digital Clock Functions

- This unit also has a built-in digital clock, which is displayed when the unit is in Standby Mode or when you press and hold the **Program** key for two seconds during the CD or Radio operation.
- To set the correct time, follow the procedure below:

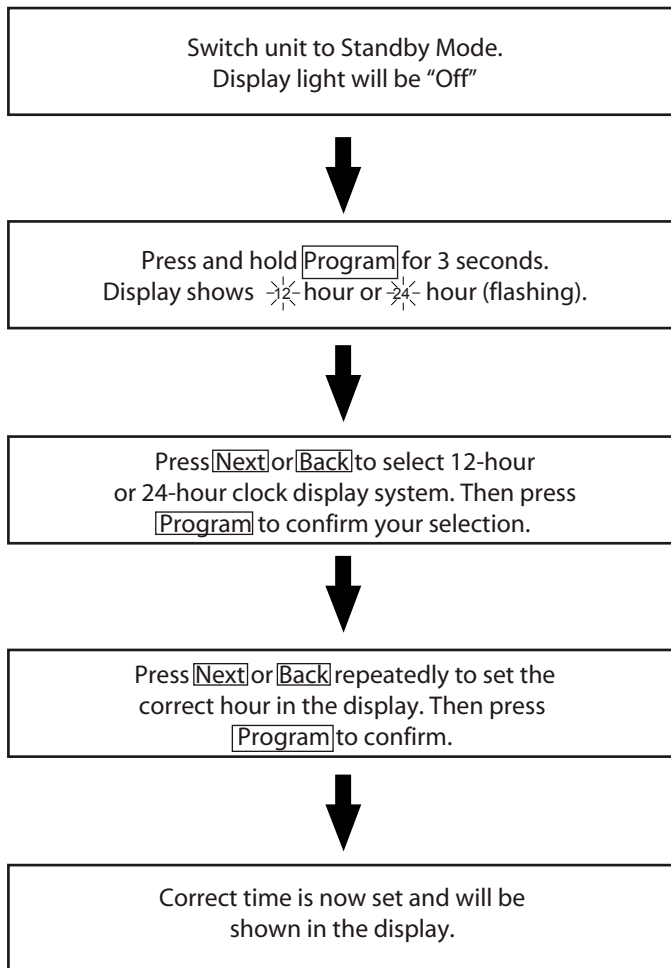

EXAMPLE OF  
12-HOUR CLOCK

PM 3:25

EXAMPLE OF  
24-HOUR CLOCK

15:25

## Automatic Power On/Off Timer Function

This unit has a timer function that enables you to program the unit to automatically turn "On" or "Off" at preset times. This function can also serve as an alarm clock.

### How To Set Timer

01. Press and hold **Timer** key. The symbol appears in the display.
02. Press **Next** or **Back** key to adjust the hour of the desired "Power on" time and then press **Timer** key to confirm.
03. Press **Next** or **Back** key to adjust the minutes of the desired "Power on" time and then press **Timer** key to confirm.
04. Now the symbol in the display changes to show .
05. Press **Next** or **Back** key to adjust the hour of the desired "Power off" time and then press **Timer** key to confirm.
06. Press **Next** or **Back** key to adjust the minutes of the desired "Power off" time and then press **Timer** key to confirm.
07. Now the display will indicate the "Wake Up Mode" (CD, Tuner, USB or SD-card). Press **Next** key to choose the desired mode and press **Timer** key to confirm.
08. The display then shows the "Wake Up Mode Level" (Loudness). Press **Next** or **Back** key to decrease or increase the volume level to be used for the music to be played when the timer switches on the unit at the pre-set time.
09. Press **Timer** key to confirm. The unit will then automatically display all your settings in sequence:

"Power On Time" ☰ On

"Power Off Time" ☰ OFF

"Power On Mode" CD OR TUNER

"Power On Volume Level" LOUDNESS

10. Finally the unit will return to the normal display, except this the symbol ☰ will be shown, to indicate that you have programmed a power on/off alarm setting.
11. In case you wish to disable the timer, press timer and the symbol disappears.

(NOTE: The automatic power On/Off timer will switch "On" the unit as if you have manually pressed the **Power** key. If you have selected "Wake To Radio", the exact preset radio band and station will become activated when power switches "On").

## Automatic Power Off Sleep Function

- This unit has a special sleep timer function which can automatically turn off the unit. This is useful for sleeping to music at night.
- At any time while the unit is operating (CD or Radio), press **Sleep** key repeatedly to choose the automatic "Power Off Mode".

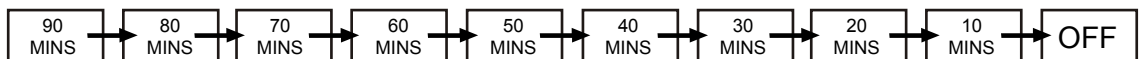

## Electronic Volume Control

- This unit uses an electronic volume control .
- To increase or decrease the loudness of this unit, press the volume up **[Vol +]** or volume down **[Vol -]** keys.
- Release the key when volume level is at the desired loudness.
- Sometimes, especially during listening to the radio, you may notice a "click-click-click" (repeating) sound when you are increasing or decreasing the volume. This is a normal condition and the sound will disappear when you release the volume key (when you reach the desired volume level).

## Volume Memory Level / Gradual Loudness Function

- This unit will remember the last setting of the volume control level (loudness) each time you switch on the power.
- This means that the volume level of the unit when you switch off the power will be stored in memory, and the same volume level will be used when you turn "On" the unit again.
- To avoid sudden loudness (in case you used the unit at high volume level before turning "Off"), the unit is also equipped with a special feature called "Gradual Loudness Function". This special function controls the volume automatically to increase it "gradually" (slowly) each time you switch "On" the unit.
- This means that the volume level will start at a moderately low level each time you power "On", and gradually go up automatically to the last volume level which is saved in memory.

## Music Equalizer

- Press the **[EQ]** key repeatedly to choose the desired sound effect according to the music you are listening to :



(\*Pass means equalizer is "by-passed" or "off")

## Auto-Start Playback Function (CD, MP3, USB, SD)

- This unit has a built-in function to automatically start playback of a CD, MP3 CD, USB-MP3 or SD-MP3 as soon as you power "On" the unit, if the last saved "Mode" of the unit was one of these modes at power "Off".
- For example, if you were listening to some MP3 songs on a USB flash drive (using built-in USB socket), and you switch "Off" the unit, then when you power "On" the unit next time, it will automatically start playing the MP3 songs on the USB flash drive, as long as there is a USB flash drive still connected to the built-in USB socket.
- This Auto-Start function also works if the unit is powered "On", and you insert a CD, MP3 CD, USB flash drive or SD card, and switch to the appropriate mode. Playback starts automatically from the first song, without the need to press **[Play]** key.

## Radio Operation

- Press the **On/Off** key once to switch on the unit.
- Press the **Tuner** key to select the desired radio band.
- For AM stations, rotate or reposition the set to improve radio reception.
- For FM stations, extend and adjust the telescopic antenna to obtain the best reception.
- Use the **FM Mono/Stereo** key to select the desired mode. In some cases, where reception is poor, it may be advisable to select "Mono" mode to improve clarity of the radio signal.

### Manual Frequency Adjustment (Scan Mode)

- Press (and immediately release) the **Next** or **Back** key to scan (manually adjust) the radio stations up or down by 1-step at a time.
- The radio digital display will indicate the exact station at each position.
- When a desired station is reached, it can be saved into one of the memory positions. See Radio Memory section.

### Automatic Frequency Adjustment (Seek Mode)

- Press and hold (for 2 seconds) the **Next** or **Back** key to seek (automatically adjust) the radio frequency up or down to the next available radio station.
- The radio digital display will indicate the exact frequency of the next station that is found.
- When a desired station is reached, it can be saved into one of the memory positions. See Radio Memory section.

### Radio Memory (Station Preset Memory Storage)

- At any time the currently displayed station or frequency can be stored into one of the memory positions.
- Press **Program** key once.
- Press **M+** or **M-** key to select desired memory position. There are 10 memory positions for AM band and 30 memory positions for the FM band.
- Press **Program** key once to save the selected station into the selected memory position.
- To recall any saved memory simply press **M+** or **M-** key, the saved radio-band will be recalled.
- To clear the memory of any position, simply save a new station to the same memory position.

IMPORTANT: Improving the radio reception.

For the FM band, fully extend the FM wire antenna at the rear of the unit.

Try to change its position until a clear reception is received.

In some areas, where FM signal is weak, you may need to switch to FM-Mono instead of stereo to improve the FM band sound quality. Use the Mono-Stereo switch.

For the AM band, rotate the unit until a desired signal is reached.

Avoid placing the unit in direct sunlight and metal desks/surfaces. This may affect radio reception.

## Insertion And Removal Of Discs

- Press the **CD** key. The display will show "CD".
- Press the **Open/Close** key to open the CD door. Carefully place a compact disc (CD or MP3 disc) onto the center of the CD spindle. Make sure the printed side of the CD is facing up before closing the CD door.
- The CD display will show the total number of tracks on the disc. After a few seconds, the CD will be ready to play.
- To remove the disc from the unit, press the **Open/Close** button. The CD door will open.
- Gently remove the CD from the CD spindle and place it back into its jewel case or protective sleeve.

CAUTION: Always hold a CD by its edges. Avoid getting any liquids, finger prints, smudges, or dirt onto the CD. If this happens, use a soft cloth or specified CD cleaning kit to remove obstructions on face of the CD.

### IMPORTANT:

#### Motorized Automatic CD Door - Operations and Precautions

- This unit has a motorized CD door.
- Please never try to open or close the door manually (by hand).
- Always use the **CD Open/Close** key
- When opening, the door will swing upwards and stop automatically. Never apply pressure on the door to close it.
- If there is any obstruction when opening the door, the door will automatically stop and reverse direction (close) after 4-5 seconds to prevent damage to the CD door.

## Normal CD Operation

- Press **On/Off** key to switch on the unit.
- Press the **Function** key repeatedly until the display shows "CD".
- Press the **Open/Close** key and insert a CD as described.
- Press **Play** key. The disk will start spinning and the first song will start to play.
- At any time during playback, press the **Play** key to "pause" the CD.
- Once the CD is paused, press the **Play** key to resume the CD.
- Pressing the **Stop** button during anytime of the CD playing will stop all operation of the CD and will reset the CD back to its first track.
- To skip forward or back in track numbers, press the **Next** or **Back** keys.
- To skip ahead or behind in a song, simply hold down the **Next** or **Back** key to desired time in song.
- At any time during playback, press and hold the **Find/Display** key for 2 seconds. The display will show the file name and song title. NOTE: This only works with an MP3 formatted disc.

## Normal CD Operation - cont.

- The CD player can be programmed to play up to 64 tracks (songs).
- Always press the **Stop** key before programming.
- Press the **Program** key once, the display will show the memory symbol to indicate that the set is now programmed into the CD player.
- There are different procedures for programming a CD and a MP3 CD. Read how below:

### Programming Procedure For Normal Audio CD:

- Press **Next** or **Back** key to select the song you would like to program.
- Press the **Program** button once to confirm your selection.
- For each additional song you would like to program, repeat steps listed above. Reminder, only 64 tracks can be programmed to play at once.
- Once all songs are programmed, press the **Program** key. The display will now show memory to indicate you have saved a program into memory.
- Press **Play** key. The CD will start to spin and play your selected tracks in the program.
- To clear out your programmed tracks, simply press the **Stop** key. This will reset the memory and clear the program.

### Programming Procedure For MP3 CD:

- Press the **Next** or **Back** key to select the Album (folder directory) number which contains the song you wish to program.
- Press the **Program** key to confirm.
- Press the **Next** or **Back** key to select the song number.
- Press the **Program** key to confirm.
- Repeat the last 4 steps, each time selecting an Album and track number to be played into your CD program.
- After a maximum of 64 tracks have been programmed, press **Play** key.
- To clear out the memory of your selected programmed songs, simply press the **Stop** key.

## Text Display Mode (ID3)

- This unit is capable of displaying the "Text Information" (ID3 Tag) of an MP3 song on the LCD.
- To turn on this function, simply press and hold the **Find/Display** key for 2 seconds.
- To switch back to normal display mode (display track number and timer) press and hold the **Find** key again for 3 seconds.

## Finding (Searching) MP3 Songs By Song Name

- During Stop or Play modes, press **Find** key once.
- The "Find" symbol will flash in the display, and the letter "A" will be shown (see example below).
- This is the "Search Alphabet".
- Press the **Next** or **Back** key to advance the Search Alphabet to select the desired letter.
- At every selected letter, the lower part of the display will show the name of the first song beginning with that selected letter on the disc.

EXAMPLE:

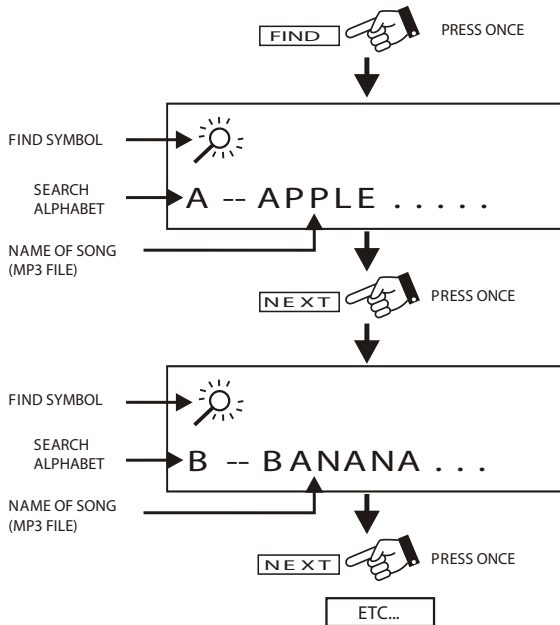

- With any selected letter, there might be several songs within that particular letter. To search for all songs beginning with that letter, press and hold **Next** or **Back** key (for 2 seconds) until the searched letter starts flashing in the display.
- Once the searched letter starts flashing, press the **Next** key to display the desired song starting with that particular letter.
- At any time, when you have located a desired song (as shown above), just press **Play** key.
- To exit the Find mode, press the **Find** key twice (2 times) until the "Find" symbol disappears from the display screen.

## Finding (Searching) MP3 Songs By Album

- MP3 files (songs) can be organized into folders (directories) when you record them on to a CD-R disc. Each folder is called an "Album" and you can (for example) organize your albums on a disc so that each album contains songs by a particular artist, or alternatively, by a different genre or type. You can organize songs and albums in any way you wish so that you can locate and play back those songs with greater ease and convenience.
- To search for songs within a particular album, press the **Find** key twice (2 times) when an MP3 CD is playing (or stopped).
- The "Find" & "Album" symbols will activate in the display, together with the number "1". This is the Album Number, as it indicates the number of the folder on the disc.
- Press **Next** or **Back** key to advance to the album number (01, 02, 03 ...). The name of each album (the directory name) will appear in the lower part of the display for each selected Album Number.

EXAMPLE:

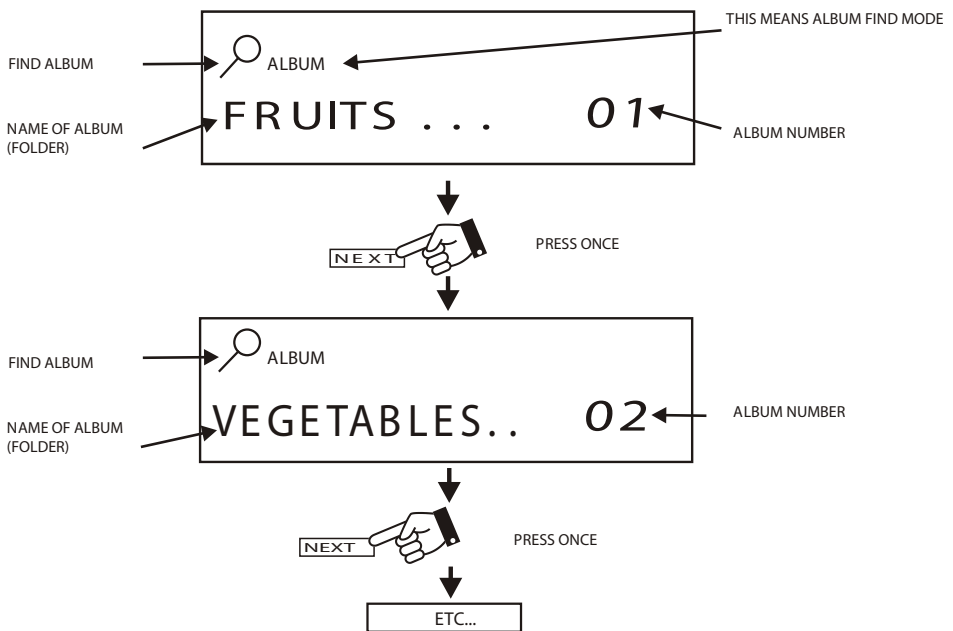

- When the desired album name appears on screen, press and hold the **Next** key for 2 seconds. This will open the selected album and now you can view (scroll through) all the songs contained inside that album one by one. You can select the desired song by using the **Next** key and play it by using the **Play** key.





THIS MEANS YOU ARE IN ALBUM FIND MODE

ALBUM

ALBUM NAME (WHICH YOU WANT TO OPEN)

VEGETABLES... 02

ALBUM NUMBER



  Press and hold for 2 seconds.

ALBUM

SONG NUMBER ON WHOLE DISC (BASED ON ALL SONGS ON THAT CD)

CARROT... 02

NAME OF FIRST SONG IN THE SELECTED ALBUM

  Press and release repeatedly to scroll through all the songs contained within the selected album.

NAME OF DESIRED SONG IN THE SELECTED ALBUM

TOMATO... 09

  Press the **Play** key to play the song displayed.

- To exit the Find mode, press the **Find** key repeatedly until the "Find" symbol disappears from the LCD display.

## USB Flash Drive / SD Card MP3 Playback

- This unit is equipped with a USB socket which can accept and play MP3 files stored on standard USB flash drives which are for memory storage. This unit is compatible with USB version 1.1 & 2.0.
- This unit is equipped with a SD card slot which can accept and play MP3 files stored on standard SD cards which are for memory storage.
- The USB and SD card sockets are located on the side of the unit as shown in the picture below.
- To utilize USB drives/SD cards for MP3-playback, insert the USB drive or SD card into the appropriate socket (as shown below) and press the **[USB/SD]** key repeatedly until the display shows "USB read" or "SD read" (depending on which one you are using).
- Press **[Next]** or **[Back]** key to skip forward or backwards to select the desired MP3 file on the USB flash drive or SD card.
- Press the **[Play]** key to start the selected song.

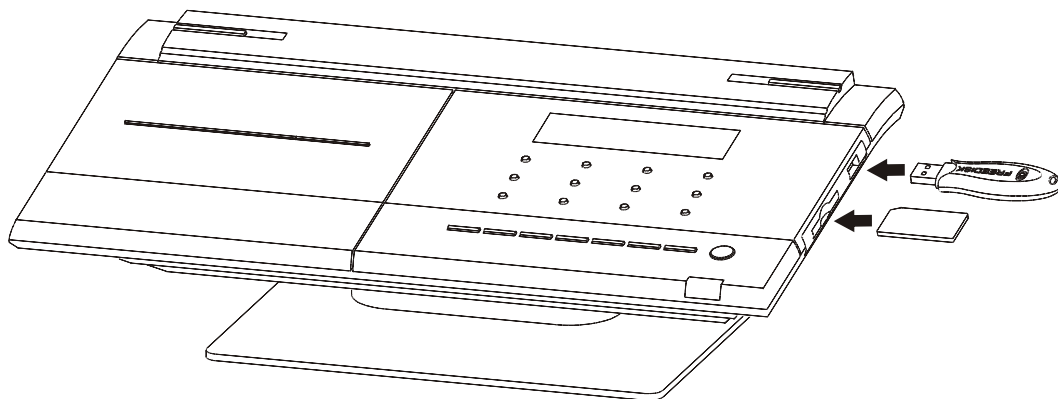

**Important:** Always turn off the unit or change mode to "CD" or "Radio" before removing a USB flash drive or SD card to prevent damage to your USB device or memory card.

**Note:** Although this product is fully compatible with USB 1.1 and 2.0, and SD card standard formats, a small percentage (about 5%) of USB flash drives and SD cards might not be readable due to those device manufacturers, not-compliant with the full (official) USB and SD card standards.

## Displaying The Song Name (ID3)

Remember to press and hold the **[Find]** key for 3 seconds to turn on the Text Display Mode. This enables the ID3 Tag to display onto the LCD display screen.

## Play Modes (CD, CD MP3, USB MP3, SD MP3)

- During anytime of play mode, press **Play-Mode** key repeatedly to select from the following:

Repeat	To repeat current track.
Repeat Album	To repeat all songs from currently selected Album (available for MP3 only).
Repeat All	To repeat all tracks from any type of media.
Intro	To sample the first 12 seconds of all music using any type of media.
Random	To play a random mix of all of the songs on all media types.

## Anti-Skip (Anti-Shock) Function

- This unit has a built-in digital anti-skip function which prevents CD skipping when the unit is physically moved or subjected to vibrations when playing songs from a CD media.
- Whenever any MP3 CD is played, the anti-skip memory needs the first 30 seconds to become filled up. During this time, the anti-shock protection is already active, but is not used to the max. 30-sec. capacity.
- After the first 30 seconds have elapsed, the anti-shock memory is full and the unit now provides anti-skip protection for 30 seconds of vibration when playing CD-MP3 discs. NOTE: There is no anti-shock protection when playing a normal audio CD.
- Please note that the anti-skip function only protects against normal vibration or minor movement. Severe or strong shocks/vibrations to the unit may still cause the unit to skip.

## Using The Audio Line-in Connection (DVD/AUX)

- You can connect the audio output of an external device such as a MP3 player or DVD player to this unit to listen to the sound of that device through the high-quality amplifier of this music system.
- To connect the external device, please use a standard RCA cable to connect the "Audio Line-out" (or head phone stereo audio output) of the device (left and right channels) to the "Aux Audio Line-in" RCA jacks (left and right) on the rear panel of this unit.
- Make sure that the speakers are connected to the main unit.
- Turn on the power of the main unit and the external device (Eg. MP3 or DVD player).
- Press the **Aux** key on the front panel.
- Start playback of the external device and adjust the volume control of the main unit to the desired level.

## Connecting An External Powered Subwoofer (Not Included)

- This unit has a built-in subwoofer connection which can be connected to any standard powered subwoofer.
- By connecting to a powered subwoofer, the low frequency (Bass sound) can be strongly enhanced to provide a much richer and deeper sound to your music.
- To use this facility, simply connect any standard powered sub woofer (easily available from most music equipment shops) using the RCA jack on the rear panel of the main unit.
- Switch "On" the powered subwoofer.
- Play any music source (CD, Radio, or Aux.) as usual.
- You will immediately notice the deeper sound, which can be further enhanced by switching on the "super bass" function on The main unit.
- Please note that the speakers should be connected as usual to the main unit, when using a subwoofer.
- Please note that "Passive" (non-powered) subwoofers will not work with this unit.

## Specifications

AC power supply:	AC 110V/220V ~ 50/60Hz
AC power consumption:	40W
Remote control unit:	3V (AAA size / UM-4 / LR03 / R03G x PCS)
Battery backup (Main Unit):	3V (AA size / UM3 / LR6 x 2 PCS) (Batteries not included for both above)
Speaker:	6-way speaker system (2 x Tweeter / 2 x Mid / 2 x Woofer)
Speaker capacity power:	2 x Tweeter: 2" / 8 Ohm / 5W 2 x Mid: 4" / 4 Ohm / 2W 2 x Woofer: 4" / 4 Ohm / 10W
Amplifier maximum power:	10W RMS total

This unit should not be exposed to object that drip or splash of any liquids or filled with liquids. This unit should not have any foreign object placed on top of it.

The marking is located at rear enclosure of the unit.

The mains plug is used as the disconnect device and it shall remain readily operable. To be completely disconnected the power input, the mains plug of the apparatus shall be disconnected from the mains completely. The mains plug should not be obstructed or should be easily accessed during intended use.

Under the influence of electrostatic phenomenon, the product may malfunction and may cause the user to reset the power.

## System Setup Procedure

### A. Shelf Use Setup (For Table / Desktop Use)

- The main unit can be placed on a flat surface either with or without the supplied pedestal. See below.

#### Desktop use without pedestal stand

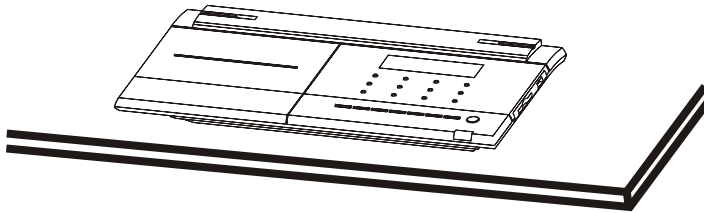

- Place the main unit on a flat stable surface as shown. There are rubber legs on the bottom of the unit which will help stabilize it and protect the table from scratches.
- Avoid placing the unit on metal surfaces as it may cause interference with frequencies or stations.
- Leave at least 6" of space around the unit for ventilation.

#### Desktop use with supplied pedestal stand

PANEL COVER

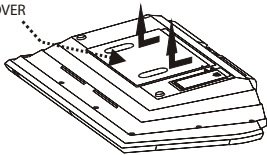

Step 1: Remove this panel cover from the bottom of the main unit.

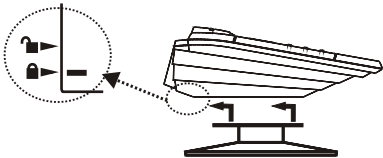

Step 2: Install the supplied pedestal stand to the bottom of the main unit as shown. Make sure that the stand is fully and securely fitted and does not come off when the main unit is picked up.

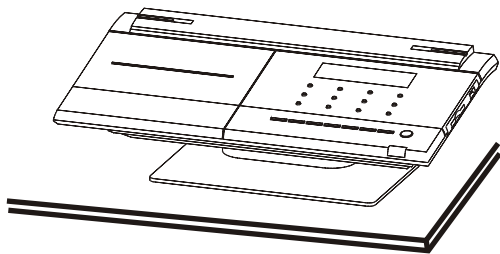

Place the unit on a flat stable surface. Remember to keep adequate ventilation space all the way around the unit to prevent overheating.

## B. Wall Mount Setup

- The main unit and speakers can be mounted onto a wall surface with the use of the supplied wall bracket and screws.
- You can use the supplied paper templates to mark the screw hole positions on the wall first, and then drill holes and carefully screw the wall bracket to the wall in the exact desired position.

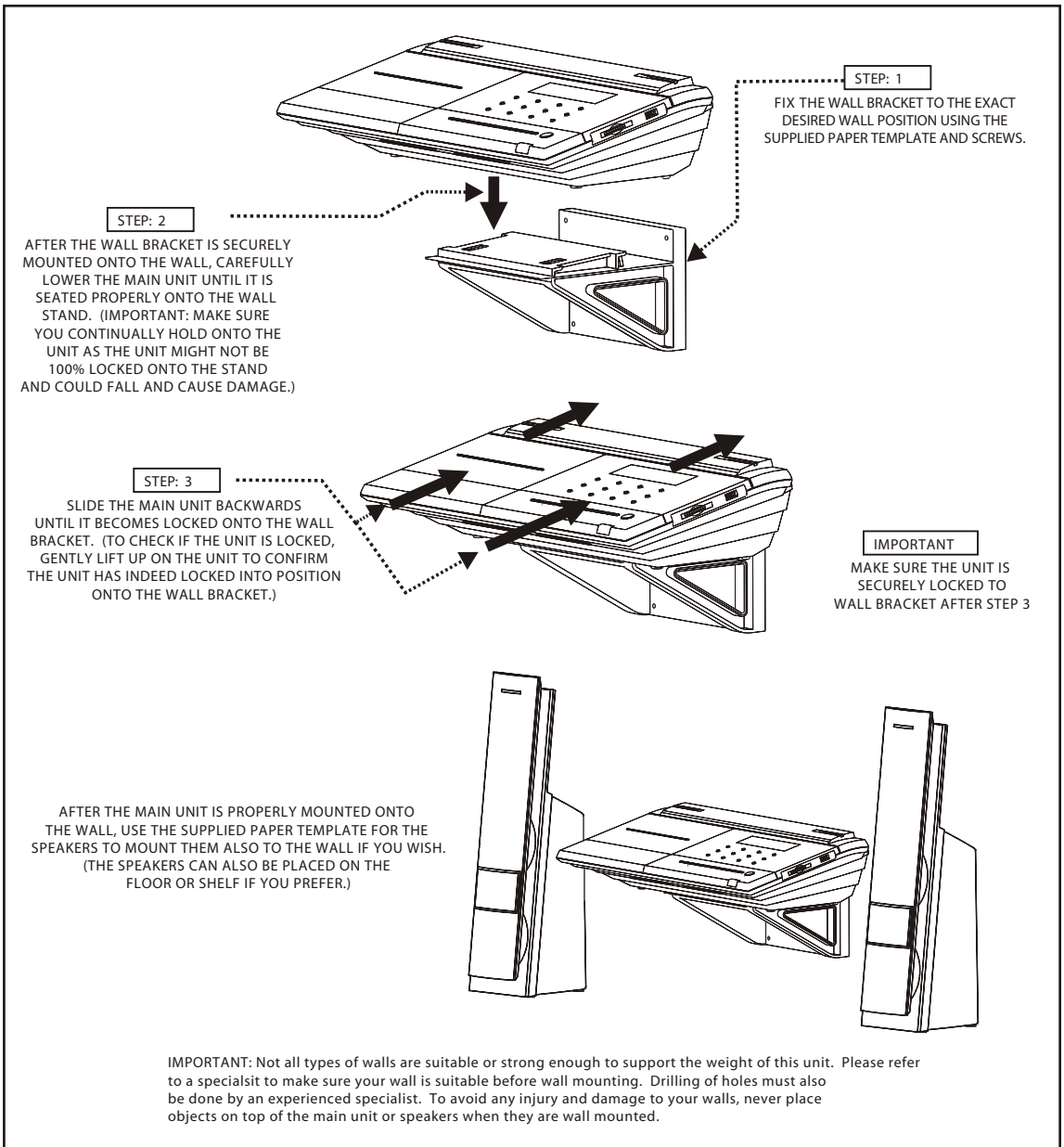



Auvi Electronics N.A. & Auvi Electronics L.A.

Retail Divisions of Auvi Technologies  
5988 Mid Rivers Mall Drive  
St. Charles, MO 63304  
[www.auviworld.com](http://www.auviworld.com)

For customer service inquiries in the U.S. and Canada, please email [custservice@auviusa.com](mailto:custservice@auviusa.com).

For customer service inquiries in Latin and South America, please email [custserviceLA@auviworld.com](mailto:custserviceLA@auviworld.com).

© 2006 Auvi Technologies, LLC. All Rights Reserved. Auvi Electronics N.A., LLC and Auvi Electronics L.A., LLC are separate subsidiaries of Auvi Technologies, LLC. All the mentioned trademarks or trade names are the property of their respective owners. Specifications of product features are subject to change without notice, which might alter the functionality described within this instruction manual.